

Tubular Column TFC4X76

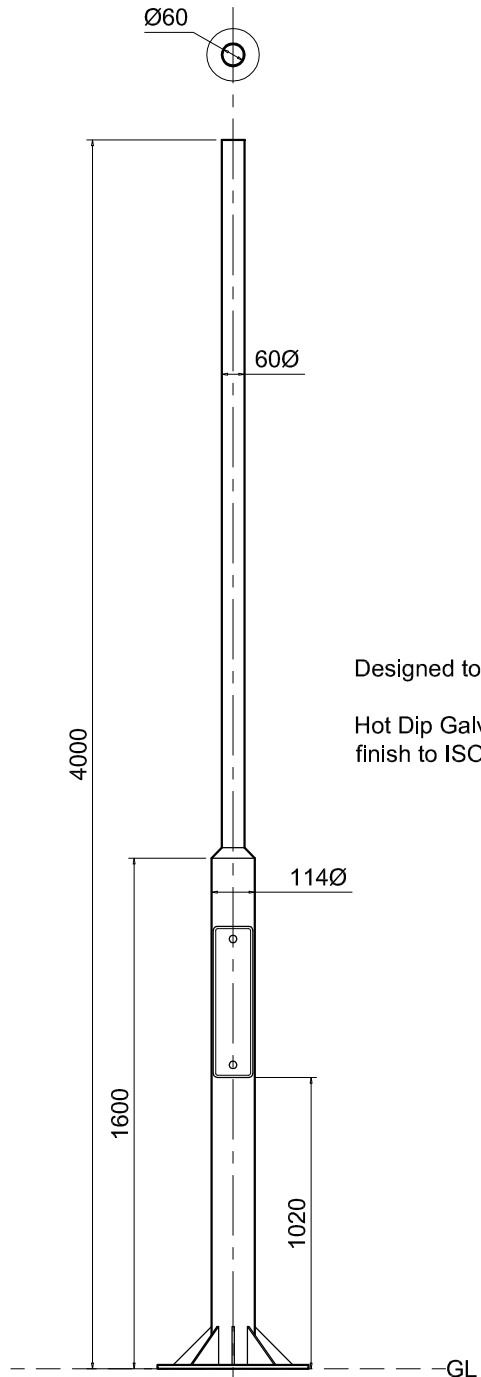

Designed to ISO EN 40

Hot Dip Galvanized coated
finish to ISO EN 1461

